

中量ラック 200kg / 段 (H1200)

間口 (mm)

奥行き (mm)

標準棚板有効高さ (mm)

3段

4段

5段

6段

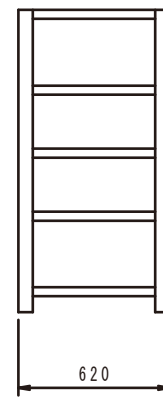
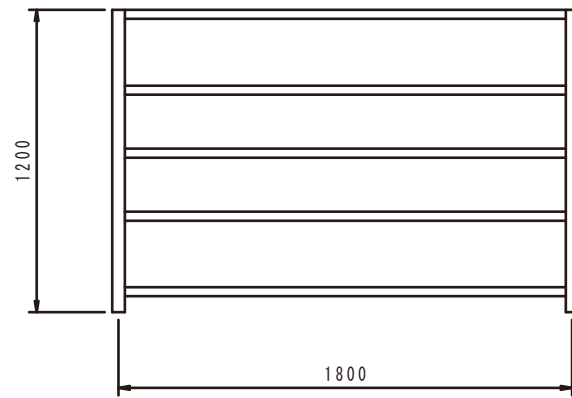
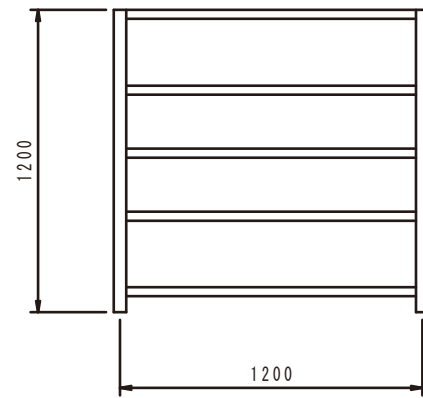
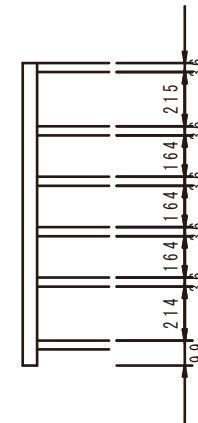
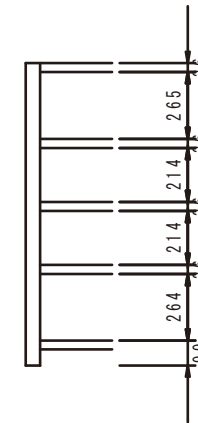
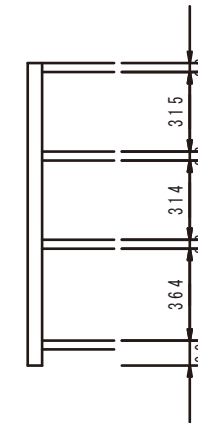
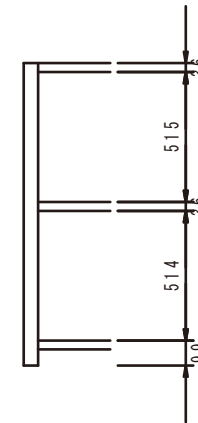
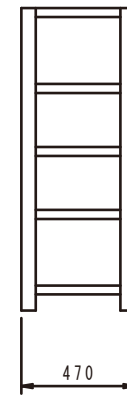
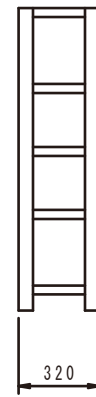
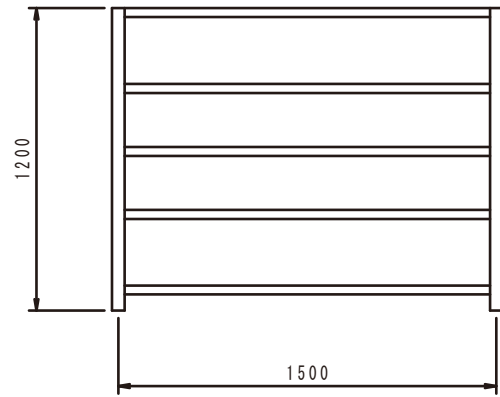
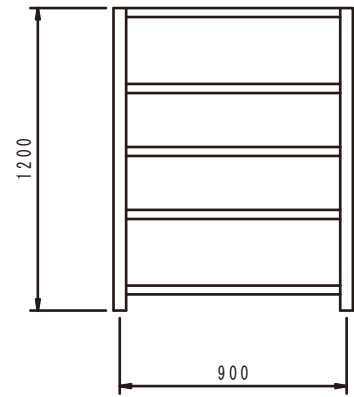

中量ラック 200kg / 段 (H1500)

間口 (mm)

奥行き (mm)

標準棚板有効高さ (mm)

3段

4段

5段

6段

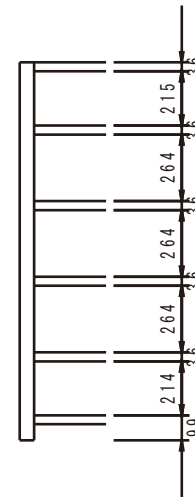
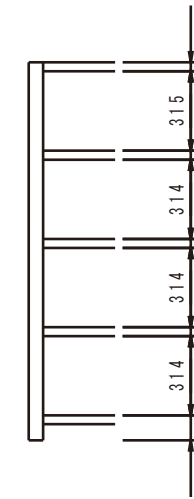
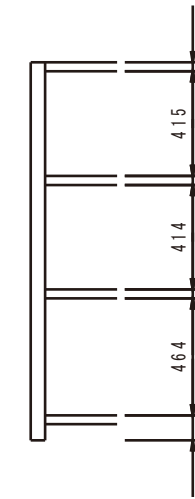
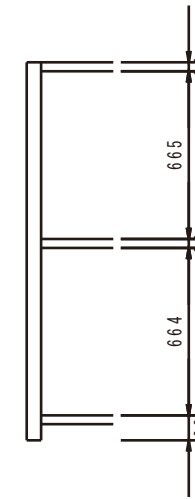
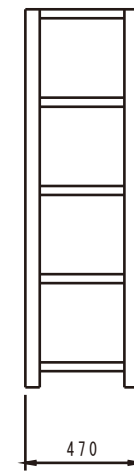
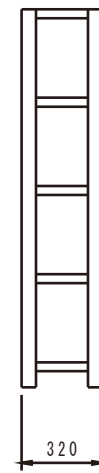
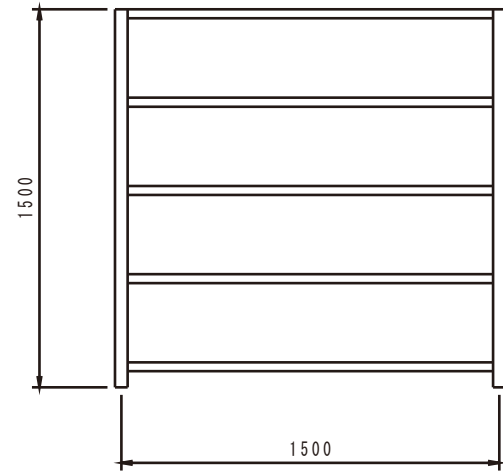
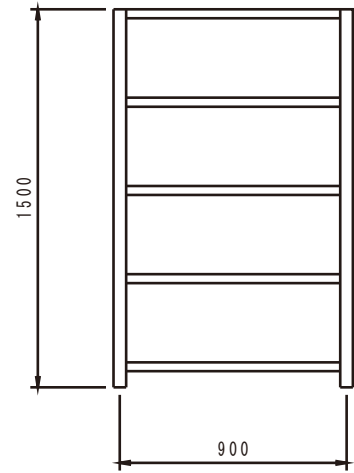

7段

8段

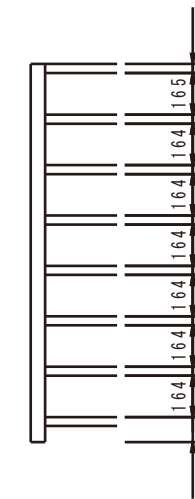
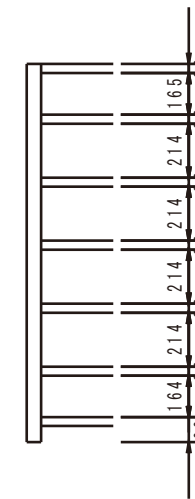
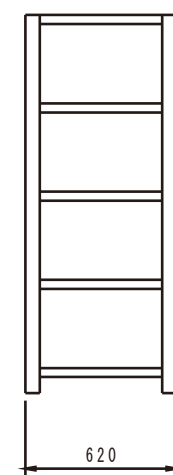
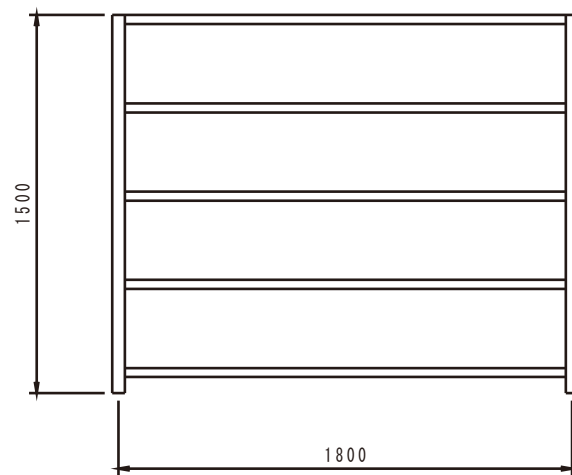
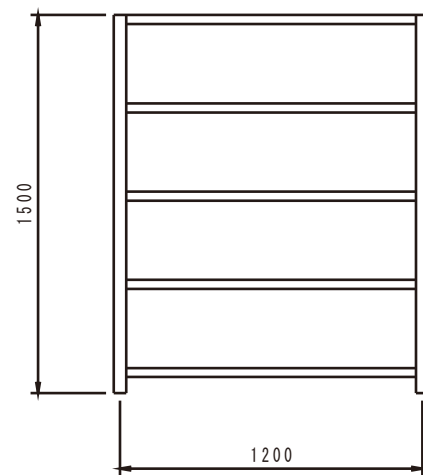

中量ラック 200kg / 段 (H1800)

間口 (mm)

奥行き (mm)

標準棚板有効高さ (mm)

3段

4段

5段

6段

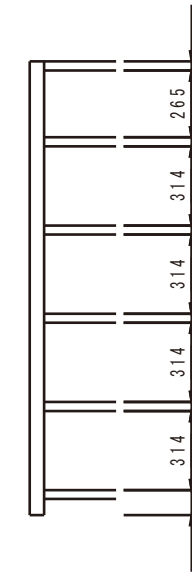
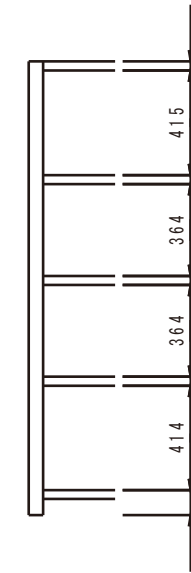
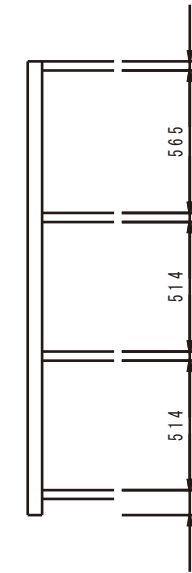
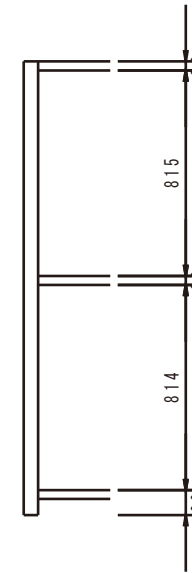
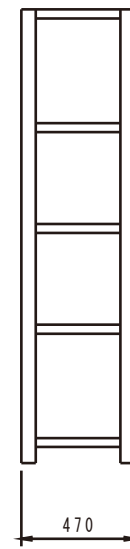
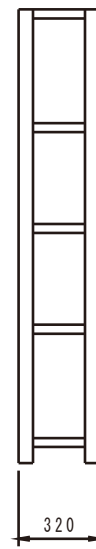
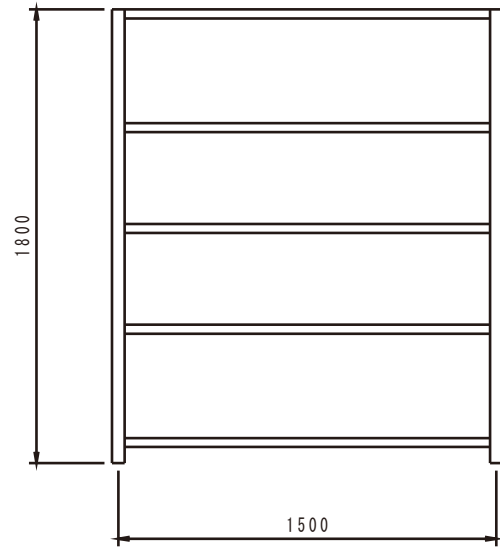
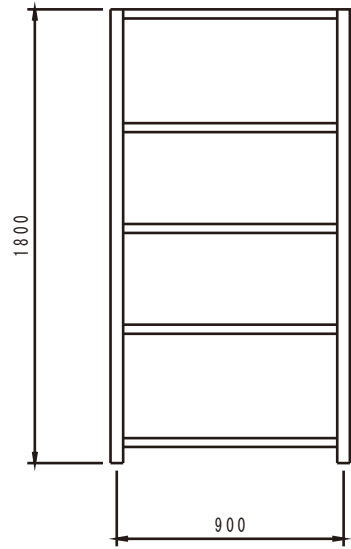

7段

8段

9段

10段

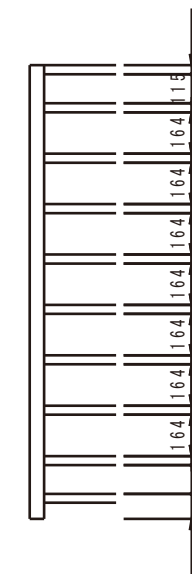
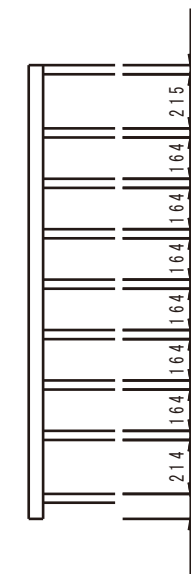
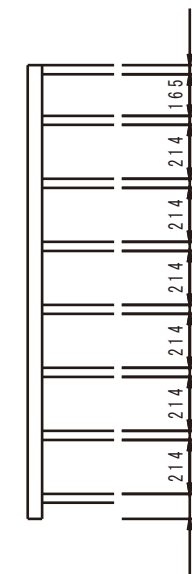
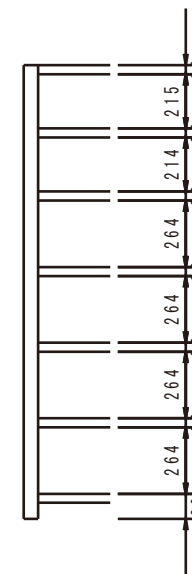
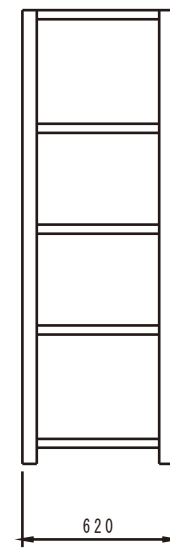
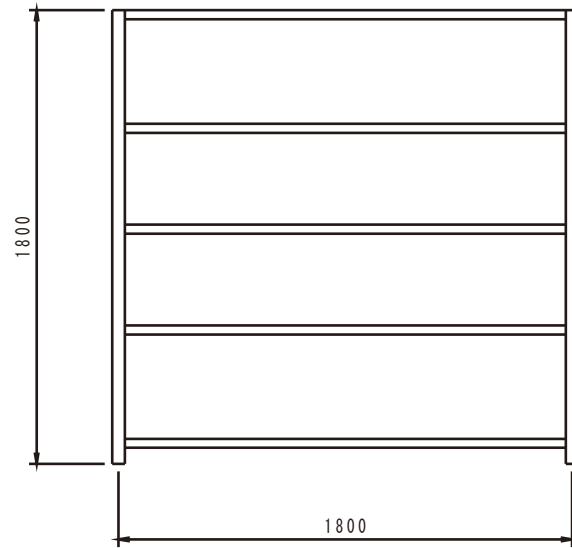
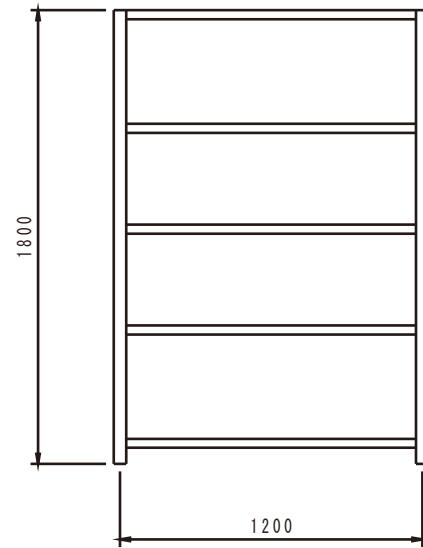

中量ラック 200 kg / 段 (H2100)

間口 (mm)

奥行き (mm)

標準棚板有効高さ (mm)

3段

4段

5段

6段

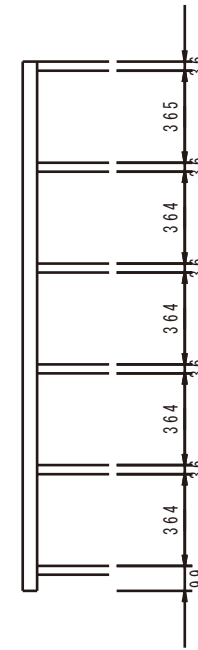
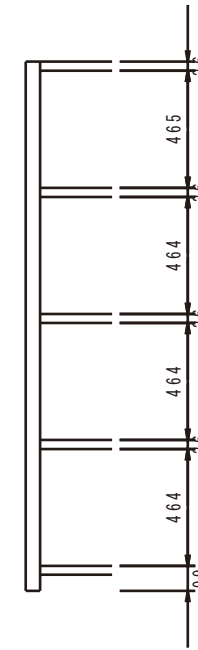
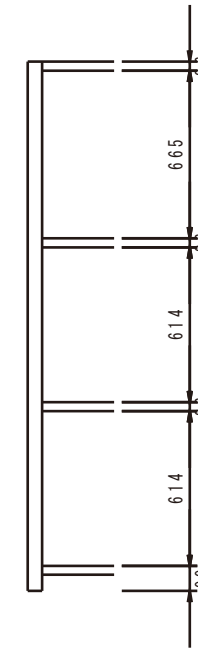
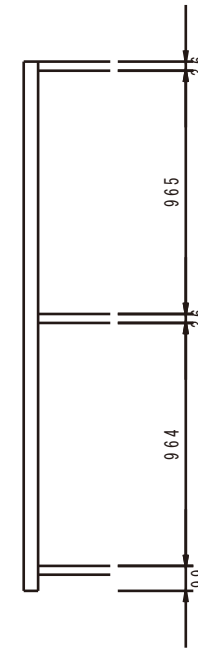
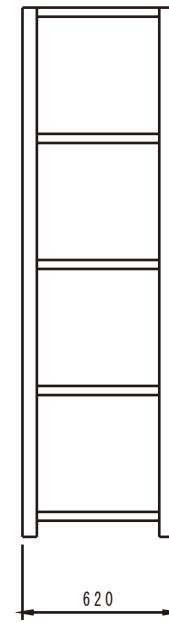
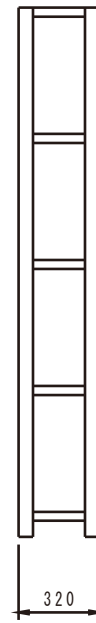
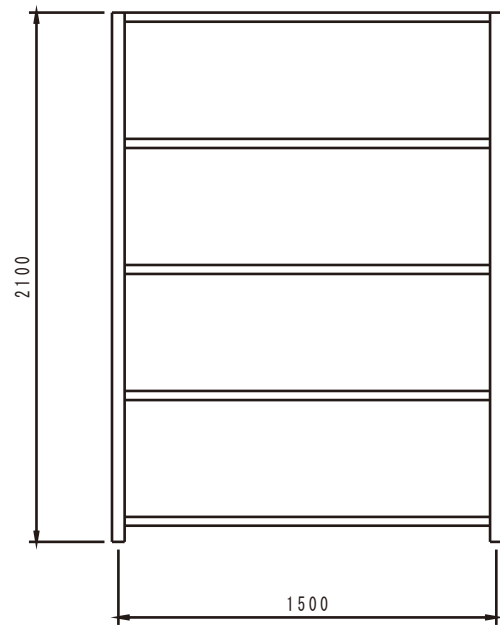
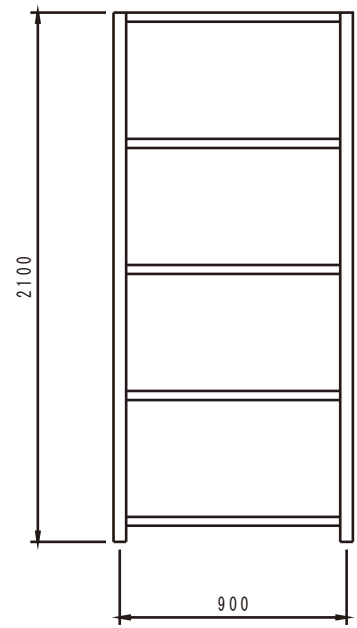

7段

8段

9段

10段

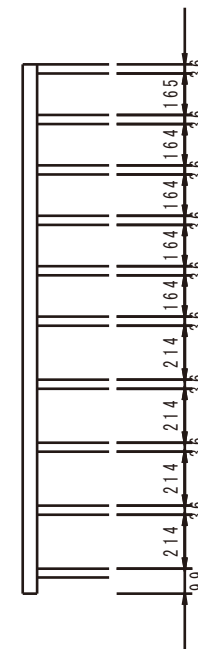
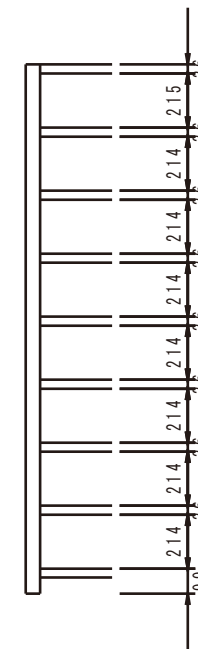
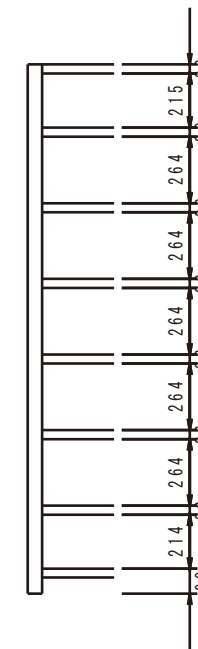
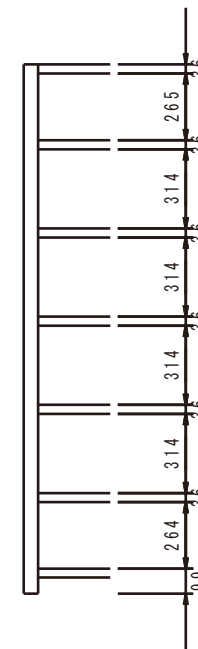
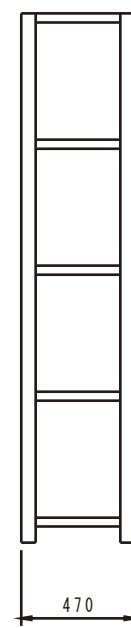
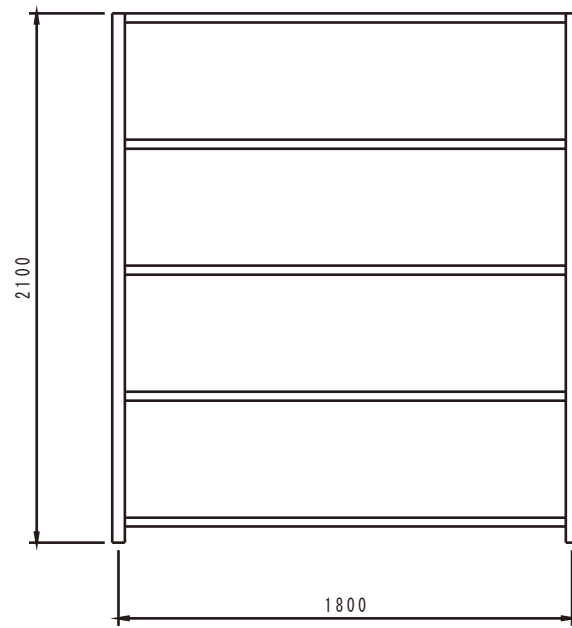
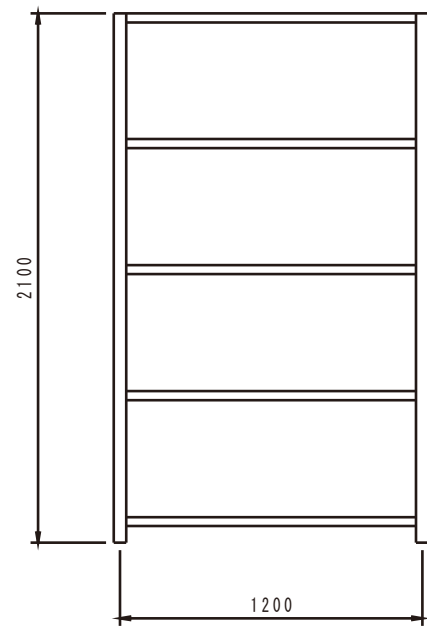

中量ラック 200 kg / 段 (H2400)

間口 (mm)

奥行き (mm)

標準棚板有効高さ (mm)

3段

4段

5段

6段

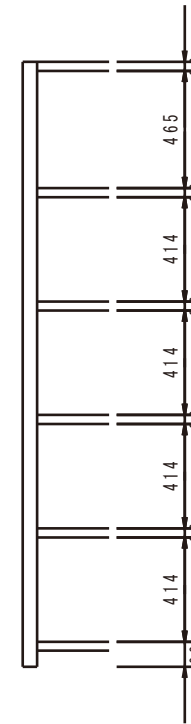
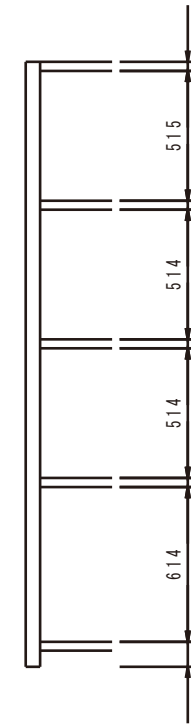
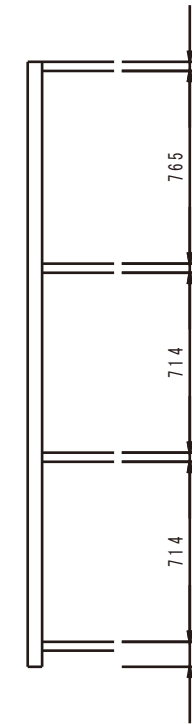
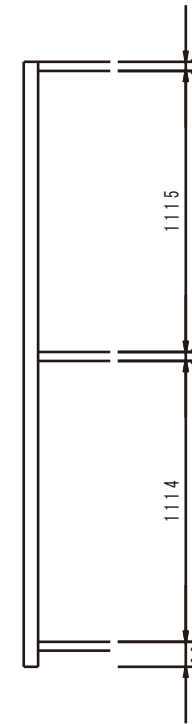
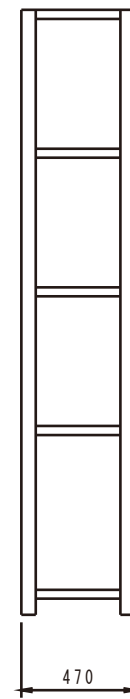
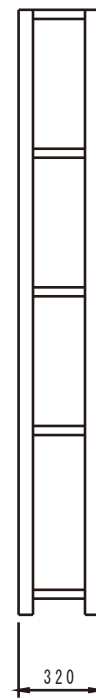
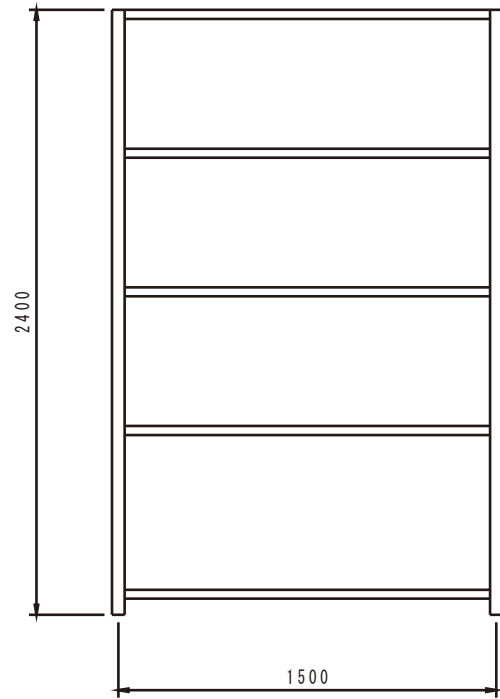
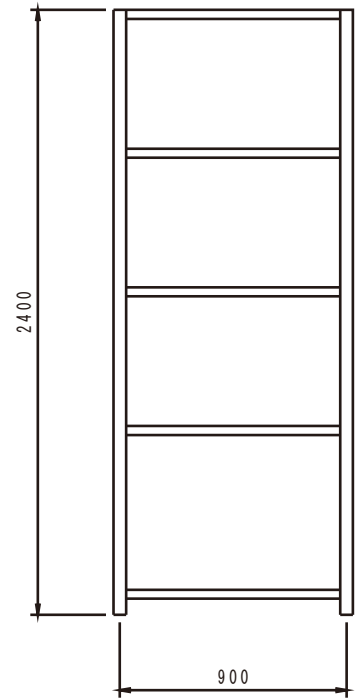

7段

8段

9段

10段

